

# SALVAJOR® Food Waste Disposer 2 HP - Model 200

JOB: \_\_\_\_\_

Item No.: \_\_\_\_\_



## NEMA 4 Watertight Controls



**MSS**



**MRSS**



**ARSS-2**



**ARSS**



Optional Line Disconnect (LD) available on MSS, MRSS, & ARSS

## SPECIFICATIONS:

### CORROSION RESISTANT BODY

Permanent molded from heat treated aluminum alloy.

### EXTENDED LIP WATER SEAL

Protects the motor from damage by water.

### TAPERED ROLLER BEARING

Provides longer motor life, quiet operation and shock absorbing.

### WATER COOLED MOTOR

Provides maximum efficiency and longer life.

### QUIET OPERATION

Extra thick rubber mounting adaptor and drain outlet isolates sound and eliminates vibration.

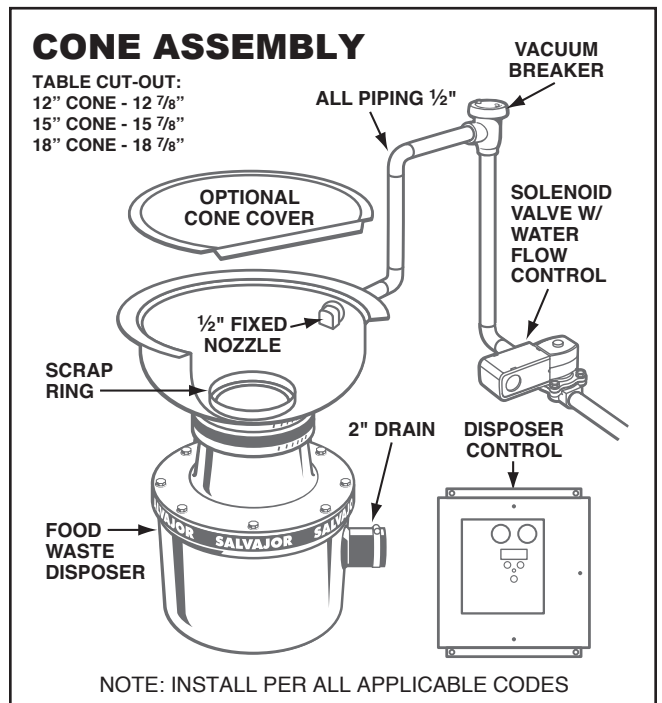

## FULL LOAD AMPS

<input type="checkbox"/>	115 Volts	1 Phase	24 Amps
<input type="checkbox"/>	208 Volts	1 Phase	12.1 Amps
<input type="checkbox"/>	230 Volts	1 Phase	12.0 Amps
<input type="checkbox"/>	208 Volts	3 Phase	6.6 Amps
<input type="checkbox"/>	230 Volts	3 Phase	6.0 Amps
<input type="checkbox"/>	460 Volts	3 Phase	3.0 Amps

◆ SPECIFY EXACT OPERATING VOLTAGE ◆

# Model 200 Food Waste Disposer

## 2 HP - 1 Phase & 3 Phase

### SPECIFICATIONS:

**MOUNTING** – Rubber adaptor above grind chamber and rubber drain outlet isolates sound and eliminates vibration. No metal to metal contact.

**EXTERIOR HOUSING** – Permanent molded from heat treated, corrosion resistant aluminum alloy then computer machined to a smooth polished finish. Paint free.

**SHREDDER** – 8 inch diameter, machined high strength, wear resistant hardened carbide alloy.

**ROTOR** – 8 inch diameter with 2 cutter bars, machined high strength, wear resistant hardened carbide alloy.

**MOTOR** – 2 HP totally enclosed. Water cooled for efficiency and longer life. Built-in manual reset thermal overload protection. Available in 208 volts or 115/230 volts, 60 cycle, 1 phase and 208-230/460 volts, 60 cycle, 3 phase.

**BEARINGS** – Tapered roller (top)  
Sealed ball (bottom)

**SEAL** – Extended Lip Water Seal.

**WATER REQUIREMENT** – 5 gallons of cold water per minute.

**WASTE OUTLET** – Rubber drain accepts 2" piping.

**DUAL DIRECTION GRINDING** – Designed to operate in either direction. Direction of rotation can be controlled when installed with automatic reversing controls.  
*Reversing rotation can double cutting teeth life.*

**LEG SUPPORT (Optional)** – Single leg, adjustable.

**ASSEMBLIES:** (See Specification Sheet)

- CA – Cone Assembly with 12", 15" or 18" Cone
- SA – Sink Assembly with 3 1/2" or 6 1/2" Sink Collar

**DISPOSER CONTROLS:** (See Specification Sheet)

- MSS: (Non Reversing)
- MRSS: (Manual Reversing)
- ARSS-2: (Automatic Reversing)
- ARSS: (Automatic Reversing with Water Saver)

### DIMENSIONS

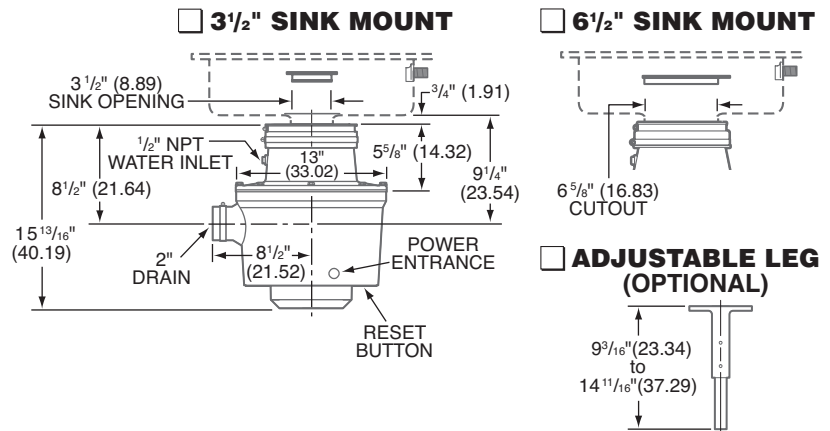
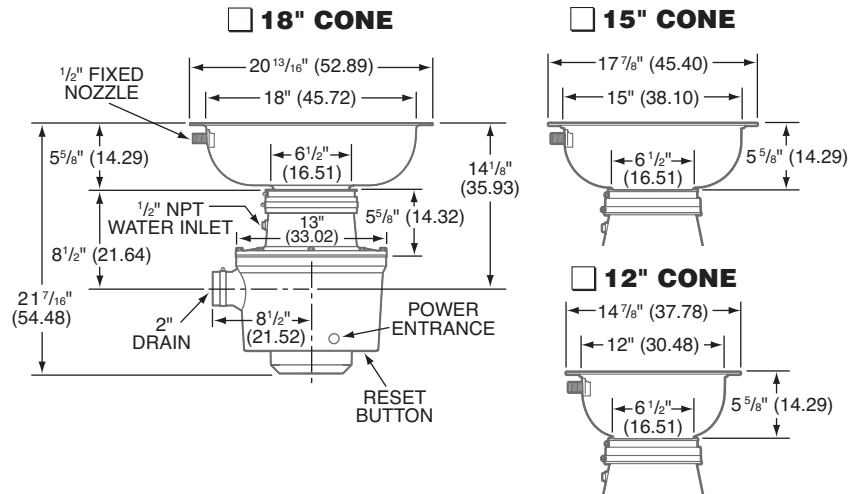

NOTE: Dimensions in parenthesis are in centimeters  
(Specifications subject to change without notice)  
Current specification details may be found online at [www.salvajor.com](http://www.salvajor.com)

SAMPLE SPECIFICATION			
200-CA-18	MSS	(230/60/3)	
Model	Cone Size	Disposer Control	Electrical Specs.
Assembly			
◆ SPECIFY EXACT OPERATING VOLTAGE ◆			

# SALVAJOR



Manufacturers of Commercial Food Waste Solutions - Since 1944

4530 East 75th Terrace Kansas City, MO 64132-2081, USA  
816.363.1030 | Toll Free: 1.800.725.8256 | Service: 1.888.725.8256 | Fax: 1.800.832.9373  
sales@salvajor.com | service@salvajor.com | [www.salvajor.com](http://www.salvajor.com)

Printed in USA  
Form No.S200 (12-23)